

Kelly DC/DC Converter User's Manual

Model: KL-49DCDC-400-5



Rev.1.1
Feb. 2019

1. Introduction

This manual introduces the Kelly isolated DC-DC Converter's features, specifications and installation. Read the manual carefully and thoroughly before using the converter. If you have any questions, please contact the support center of Kelly Controls, Inc.

Kelly DC-DC Converter covers wide range of DC input voltages of 40V to 100V, and outputs DC 13.5V. It is quite efficient and reliable with a compact size.

2. Features

- No arc
- Can be controlled by key switch directly, no need of external relay
- Over temperature protection, shut down at 90°C
- Over current protection
- Low voltage protection: stop working at low battery voltage
- High efficiency with compact size and light case
- Low standby current: $\leq 5\text{mA}$
- Isolate between input and output
- The matching connectors and crimp pins will come with each DC/DC converter
- IP66 protection

3. Specifications

- Nominal input voltage: DC 48V, 60V, 72V
- Output voltage: DC 13.5V under 70°C or DC 12.2V above 70°C
- Operating voltage range: 40V-100V
- Output current: 30A
- Output power: 400W
- Operating Temperature Range: -20°C to 90°C (case temperature)
- Full - load efficiency: $\geq 93\%$
- Ripple coefficient: $\leq 1\%$
- Weight: 2.25lbs

4. Installation

Dimensions: 130mm (L)*94mm (W)*53mm (H)

The case outline and mounting holes' dimensions are shown in Figure 1, 2 and 3.

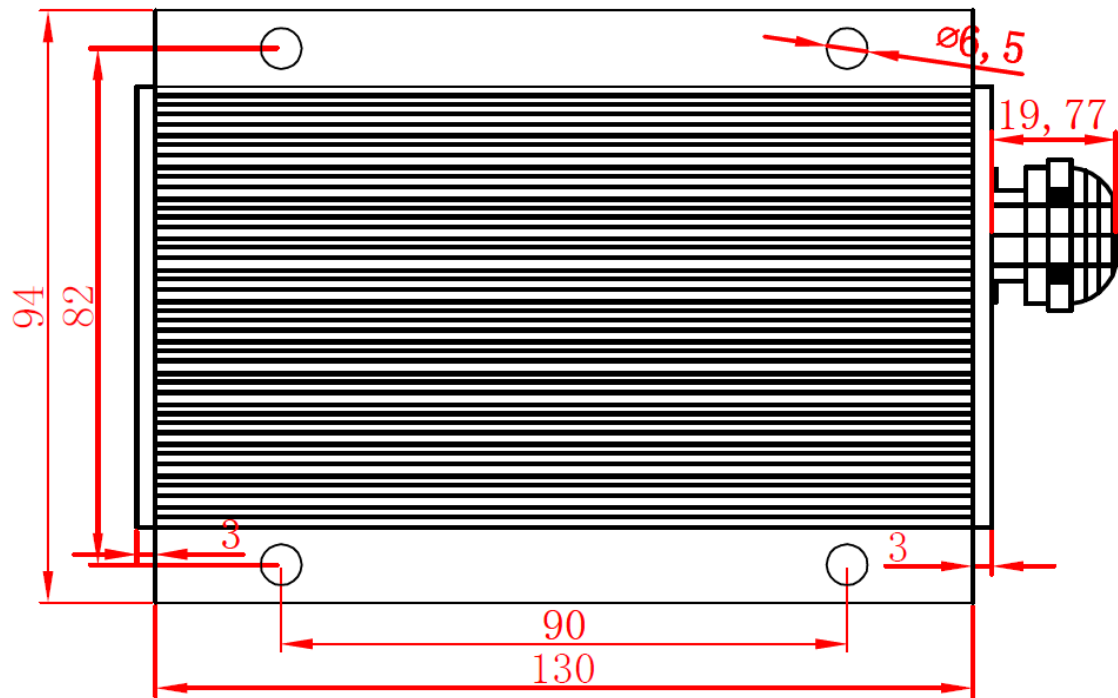

Fig.1 (Top view)

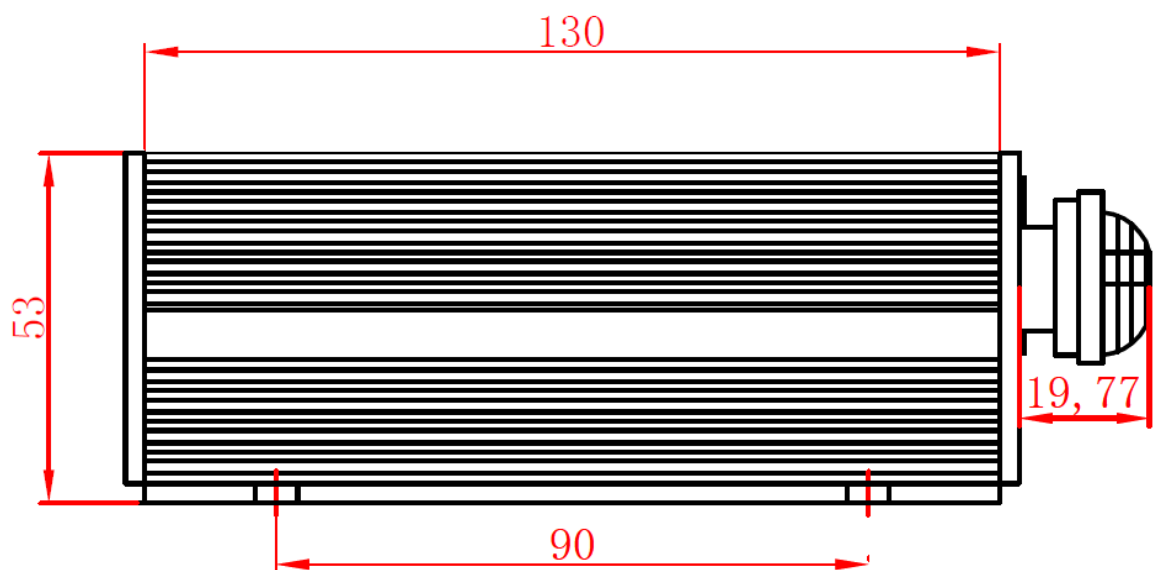

Fig.2 (Side view)

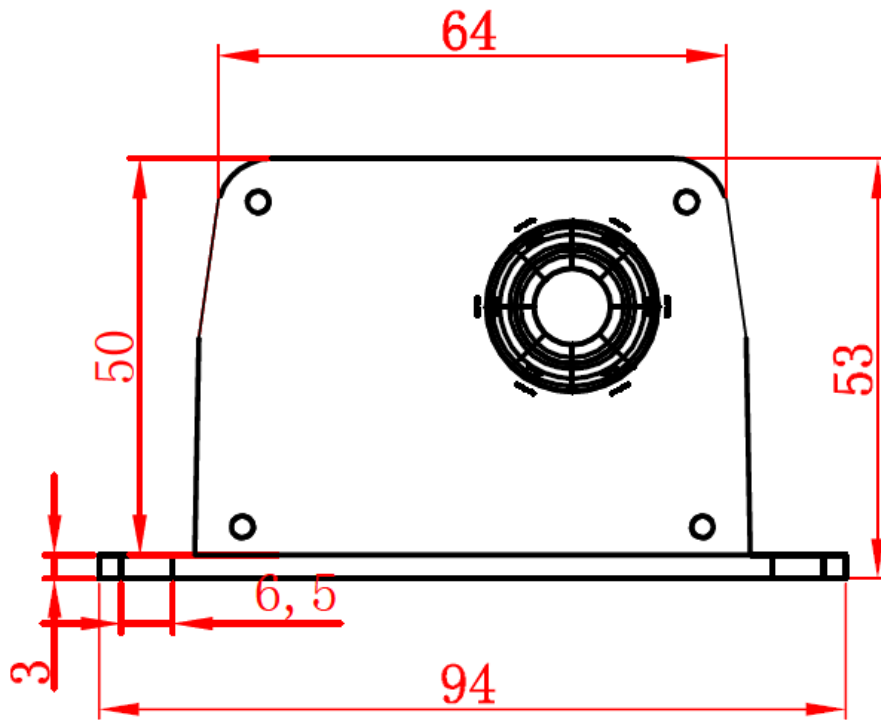

Fig.3 (Front view)

5. Characteristics Curves

5.1 Test conditions: Input voltage: 48V, Load resistance: 0.4Ω. The converter is equipped with an aluminum heat sink. Output voltage, output current and efficiency are shown in figure 4, 5, and 6.

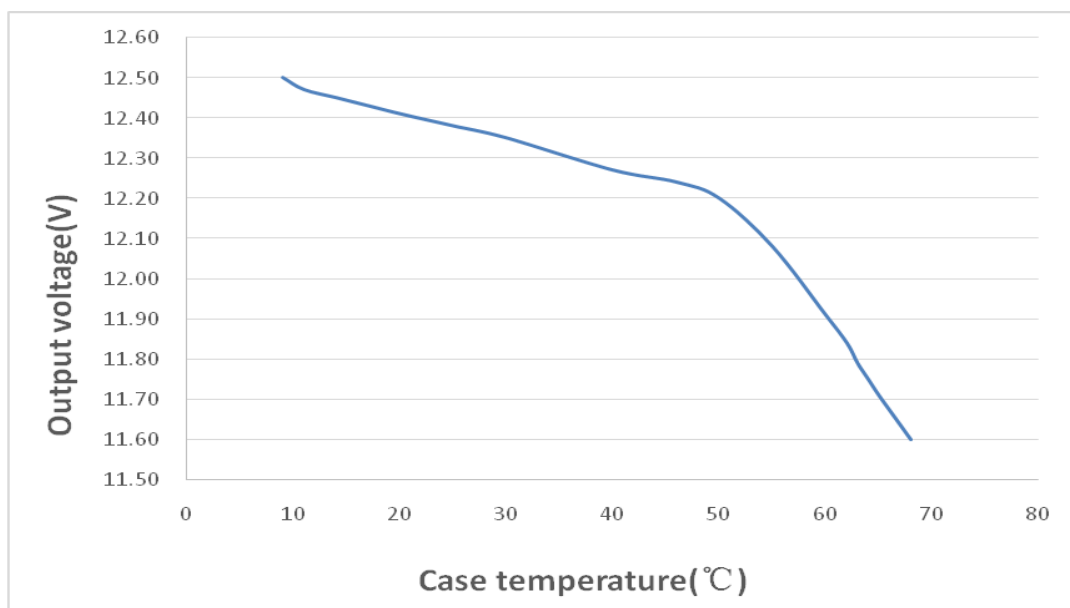

Fig.4

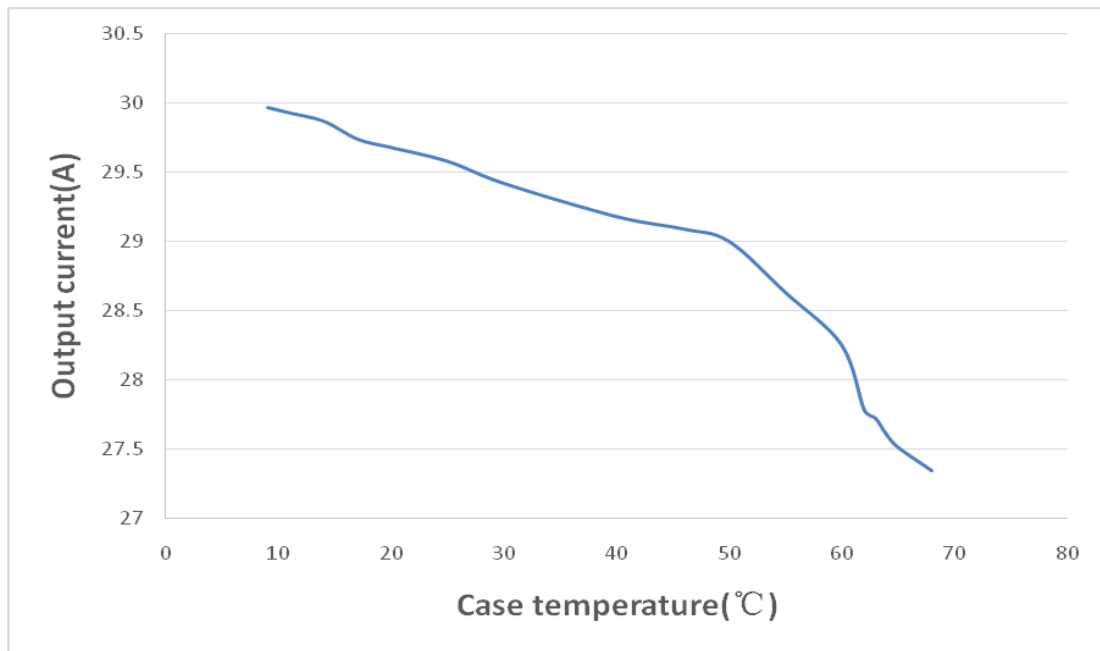

Fig.5

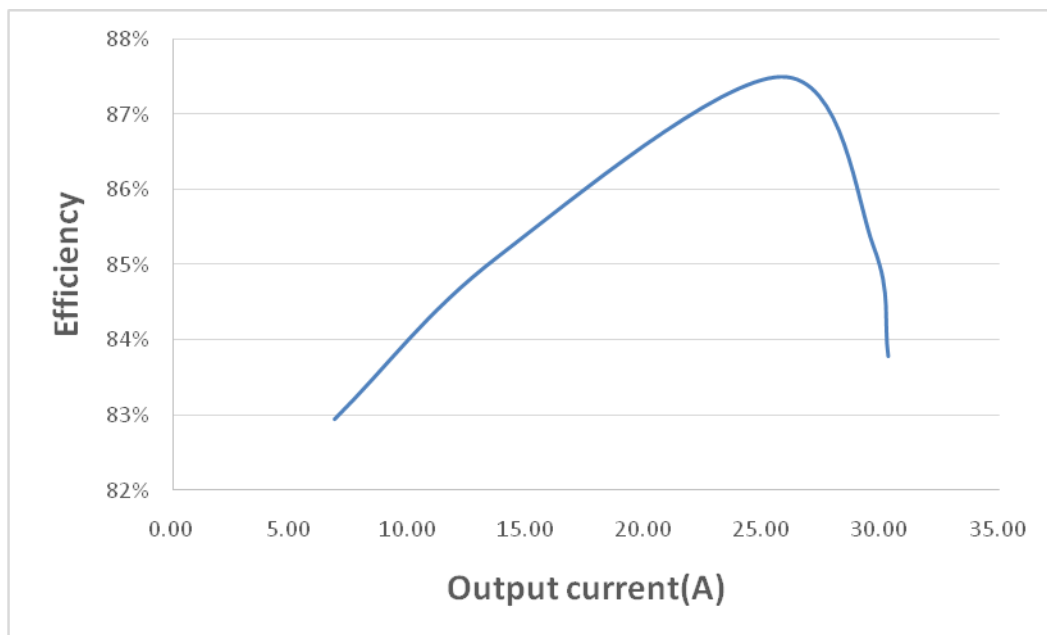

Fig.6

5.2 Test conditions: Input voltage: 60V, Load resistance: 0.4Ω. The converter is equipped with an aluminum heat sink. Output voltage and output current are shown in figure 7 and 8.

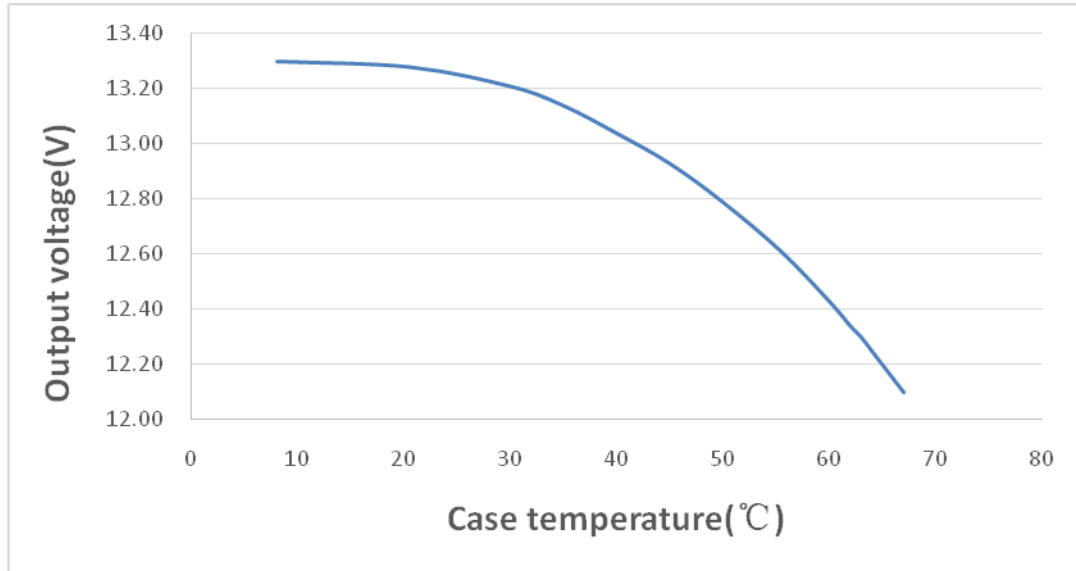

Fig.7

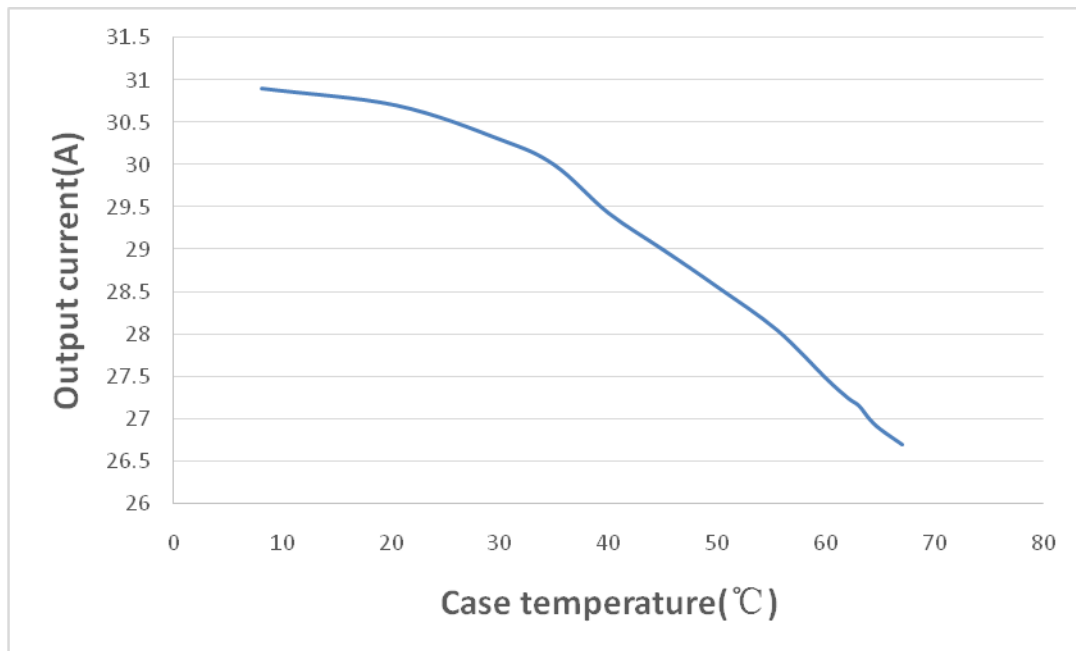

Fig.8

6. Connections

Input:

Red: Input Positive with 15A fuse(2.0mm²)

Yellow: Key Switch(2.0mm²)

Black: Input Negative(2.0mm²)

Output:

Red: Output Positive(4.0mm²)

Black: Output Negative(4.0mm²)

7. Contact Us:

Kelly Controls, Inc

Home Page:

<http://www.kellycontroller.com>

E-mail:

sales@kelly-controls.com

Phone:

(01) 224 637 5092(US)

(+86) 551-64397760(China)

(+86) 139-56008360 (China)